



ML 50

ML 50

System mebli ML50 to połączenie prostej, klasycznej formy z rozwiązaniami funkcjonalnymi pozwalającymi sprostać potrzebom organizacyjnym nowoczesnego biura. Ponadczasowa forma, solidność wykonania, doskonały dobór materiałów, regulacja wysokości powierzchni roboczych, to tylko niektóre zalety systemu ML50.

Biurka

- blaty biurek, stołów konferencyjnych oraz przystawek wykonane z płyty o grubości 25 mm,
- lekka konstrukcja wykonana w oparciu o metalowy stelaż i nogę kolumnową o przekroju 50 mm (stoły konferencyjne dostępne również na nogach talerzowych),
- pełna regulacja wysokości w zakresie 68 – 82 cm (wykręcana stopka) lub niwelacja biurka (standardowa wysokość 72 cm),
- optymalizacja połączenia biurek z przystawkami dzięki zastosowaniu tzw. nogi przestawnej,
- możliwość zainstalowania poziomych oraz pionowych kanałów na kable, paneli oraz przegród pionowych oddzielających stanowiska pracy,
- możliwość pionowej rozbudowy stanowiska pracy o półki i szafka nadbiurkowe.

Das ML 50 Möbelprogramm ist eine Verbindung der schlichten Eleganz und klassischen Form mit den funktionellen Lösungen, die es erlauben, den organisatorischen Bedürfnissen des modernen Büros gerecht zu werden. Mit dem ML 50 Möbelprogramm wird der Büroraum multifunktional und voll im Trend gestaltet. Die Form geht über das Zeitalter hinaus. Solide Ausführung, ausgesuchte Materialauswahl und die Höheinstellung des Arbeitsplatzes sind nur einige wenige Vorteile des ML 50 Möbelprogramms.

Schreib- und Anbautische

- Die Platten mit Stärke 25mm sind aus dreischichtigen Spanplatten nach Emissionsklasse E1. Die abriebfeste Melaminharzbeschichtung ermöglicht leichte Pflege. Die Platten sind kratzbeständig und zigarettenglutfest.
- Die Plattenformen liegen auf Metallgestell mit Rundfüßen von 50 mm Durchmesser. (Konferenztische optional auch mit Tellerfüßen erhältlich)
- Die besondere Rahmenkonstruktion garantiert absolute Beinfreiheit. Durch flexible Anordnung der Verbindungsmöglichkeiten wird der Fuß, wo er stört, ganz einfach zurück gesetzt.
- Die Höheinstellung im Tischfuß erfolgt stufenlos von 68 cm bis 82 cm nach DIN EN 527 - 1.
- Der Standfuß lässt sich durch manuelles drehen bei der Standardhöhe von 72 cm nivellieren.
- Jede Tischkonstruktion bietet die Möglichkeit, einen vertikalen sowie horizontalen Kabelkanal zu montieren.
- Mehr kostbaren Platz im Büro kann man durch multifunktionale 3. Ebenen gewinnen.

The ML 50 furniture system is a combination of simple, classical style and functional solutions fulfilling the needs of a modern office. Timeless form, excellence in workmanship, perfect choice of components, regulation of height of the working surfaces are only a few of the numerous advantages of the ML50 System.

Desks:

- desk tops, conference tables and other furnishings are made of 25mm melamine chipboard,
- light construction is based on a metal frame and a column leg diameter 50 mm (conference tables also available with 'plate' legs),
- flexible height adjustment in the 68 - 82 cm range or levelling of the desk (standard height-72 cm),
- optimization of desk connection with other furnishings using the so called 'moveable leg'
- possibility of installing horizontal and vertical canals for cable management, panels and vertical screens separating work stations,
- possibility of vertical expansion of the desk by adding shelves and raised-up cabinets.

Le système des meubles ML 50 est une combinaison d'une forme classique, simple et de solutions fonctionnelles permettant de répondre aux besoins organisationnels d'un bureau moderne. Forme intemporelle, réalisation résistante, parfait choix des matériaux, réglage en hauteur des postes de travail - ce ne sont que certains des nombreux avantages qu'offre le système ML50.

Bureaux

- Les plans de travail, les tables de conférence et leurs extensions sont fabriqués en panneaux à particules, épaisseur 25 mm,
- La construction légère est basée sur la structure métallique et le pied colonne f50 mm (tables de conférence disponibles également avec pieds corolle),
- Réglage en hauteur facile (par vissage ou dévissage), plage de 68 à 82 cm, ou réglage de niveau du bureau, hauteur standard 72 cm,
- Pied déplaçable permettant la combinaison optimale d'un bureau et de son extension,
- Option: goulottes, passage de câbles horizontal et vertical, voile de fond, cloison verticale séparant les postes de travail,
- Possibilité d'un troisième niveau de poste de travail (rehausses - étagères et armoires).



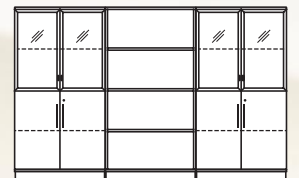
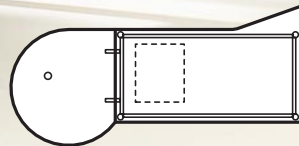

Rozwiązania stosowane w systemie ML50 pozwalają na tworzenie zarówno indywidualnych jak i gniazdowych stanowisk pracy.

Die eingesetzten Lösungen im ML 50 Möbelprogramm erlauben sowohl individuelle als auch Gruppenarbeitsplatzbildung.

Solutions applied in the ML50 System enable to create individual as well as network workstations.

Les solutions utilisées dans le système ML50 permettent d'organiser aussi bien des postes de travail individuels que des multipostes.

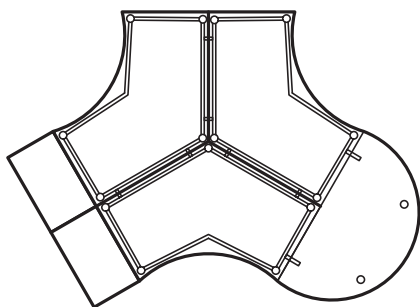

Funkcjonalny kanał na kable.

Der funktionale Kabelkanal.

Functional canal for cable management.

Passage fonctionnel pour câbles.



Domowa atmosfera w biurze lub biuro w domu.

Eine häusliche Atmosphäre im Büro oder Büro zuhause.

Homely atmosphere in the office or an office at home.

Ambiance de maison au bureau ou bureau à la maison

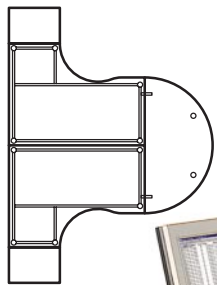
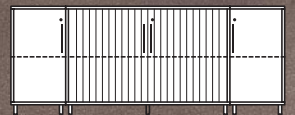
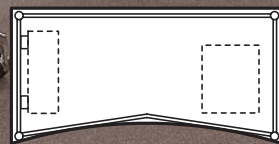

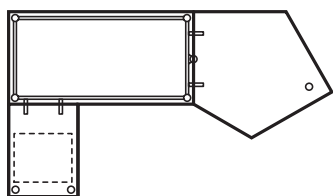
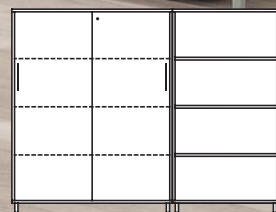
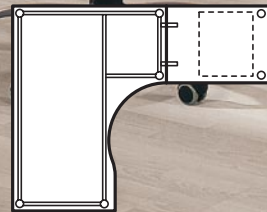

Możliwość rozbudowy stanowisk pracy w pionie:
 - dodatkowa powierzchnia,
 - poprawa ergonomii.

Arbeitsplätze haben die Möglichkeit zum vertikalen Aufbau durch multifunktionale Ebene.
 - zusätzliche Arbeitsfläche,
 - Verbesserung der Ergonomie.

Possibility of vertical expansion of workstations
 - additional space,
 - improvement in ergonomics.

Possibilité d'extension des postes de travail
 - surface de travail plus importante,
 - meilleure ergonomie.



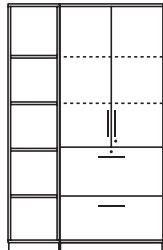
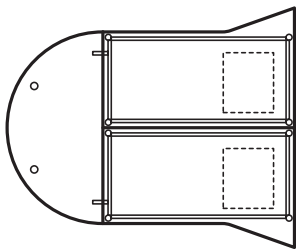

Szuflada na teczki zawieszane firmy z blokadą wysuwu i centralnym zamkiem Hettich.

Hängeregistraturschrank für DIN A4 Mappen mit zwei leichtlaufenden Schubladen, Teleskopauszug mit Auszugssperre und Zentralverriegelung von Hettich.

File drawers cabinet of the Hettich Company with the pull-out blockage and a central lock.

Tiroir avec rails pour dossiers suspendus de marque Hettich à ouverture sélective, équipé d'une serrure centrale.



Stoly konferencyjne - prostota, elegancja, solidność.

Konferenztische - schlichte Eleganz und solide Bauweise.

Conference tables - simplicity, elegance, quality.

Tables de conférence - simplicité, élégance, qualité.



Wielość brył, frontów szaf oraz sposobów organizacji ich wnętrza, zaspokaja potrzeby archiwizacji dokumentów w firmie.

Die Funktionalität und Vielheit der Schränke erleichtert die Arbeit, Ordner und Hängemappen können praktisch verstaut werden.

The number of modules, fronts of the cupboards and the arrangement of the interior fulfill the requirements of documents storage in a company.

Le choix des dimensions d'armoires, de leurs façades et l'organisation de leur intérieur satisfont aux besoins d'archivage des documents d'une entreprise.

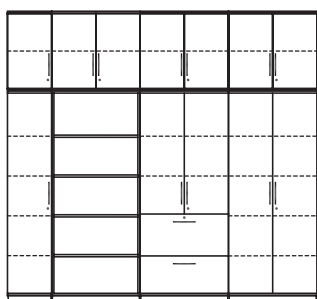

Stopka niwelacyjna umiejscowiona w metalowym cokole umożliwia precyzyjne wy poziomowanie szafy.

Bodenausgleichsschrauben im Metallsockel ermöglichen eine präzise Nivellierung des Schrankes.

A leveling foot placed in the metal socle of the cupboard enables precise levelling of the wardrobe.

Le vérin de réglage placé dans le socle en métal permet de régler le niveau de l'armoire avec précision.

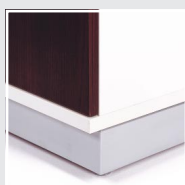

Cokół metalowy z regulacją poziomu.

Metallsockel mit Bodenausgleichsschrauben.

Metal socle with level regulation.

Socle en métal, réglable.

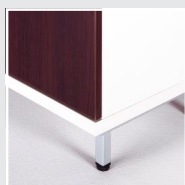

Cokół metalowy z regulacją poziomu.

Metallfüße mit Bodenausgleichsschrauben.

Metal legs with level regulation.

4 pieds en métal, réglables.

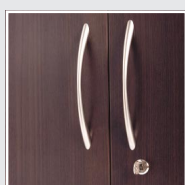

Metalowy uchwył.

Metallgriffe standardmäßig.

Metal handle.

Poignée en métal.



Zamek baskwilowy.

Drehstangenschloß.

Triple-point lock.

Serrure.



Drzwi szklane w ramie aluminiowej.

Milchglástüren mit Alurahmen wahlweise möglich.

Glass door in an aluminium frame.

Portes en verre avec cadre en aluminium.



Zawiasy otwierane do 110°, opcja 180°.

Scharniere 110° öffnend, mit Option 180°.

Hinges opening to the angle of 110°, the 180° option.

Les charnières s'ouvrent jusqu'à 110°, et en option 180°.

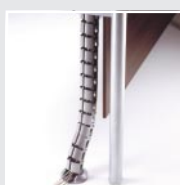

Pionowy kanał na kable.

Vertikale Kabelführung.

Vertical canal for cable management.

Goulotte, passage de câble vertical.



H-59,8



K 2/4

K 2/2

K 2/3

K 2/1



H-72,6



K 2/8

K 2/6

K 2/7

K 2/5



MC 01

MC 02

CADDY



Blenda płytowa
Sichtblende
Modesty panel
Voile de fond en plaque

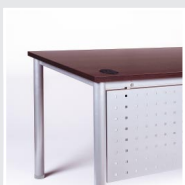

Blenda metalowa, perforowana.
Lochblechsichtblende.
Metal, perforated modesty panel.
Voile de fond en métal perforé.



Możliwość przesunięcia nogi biurka w głąb w zestawach narożnikowych.
Zurückgesetzte Füße bei Schreibtischkombinationen.
Possibility of moving the legs inward in case of corner workstations.
Possibilité de déplacement du pied vers le fond dans les combinaisons d'angle.



Noga z regulacją poziomu.
Tischfuß mit den Bodenausgleichsschrauben.
Leg with level regulation.
Le niveau du pied est réglable.



Noga z regulacją wysokości w zakresie 68-82 cm.
Stufenlos höhenstellbare Tischfüße von 68-82 cm.
Height adjustable leg (68-82 cm).
Pied réglable en hauteur de 68 à 82 cm.

BIURKA / SCHREIBTISCHE / DESKS / BUREAUX

BT 01 BA
80/80/72
BT 01 HV
80/80/68-78



BT 02 BA
100/80/72
BT 02 HV
100/80/68-78



BT 03 BA
120/80/72
BT 03 HV
120/80/68-78



BT 04 BA
140/80/72
BT 04 HV
140/80/68-78

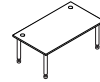

BT 05 BA
160/80/72
BT 05 HV
160/80/68-78

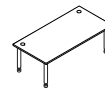

BT 18 BA
180/80/72
BT 18 HV
180/80/68-78

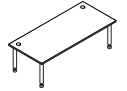

BT 06 BA
200/80/72
BT 06 HV
200/80/68-78

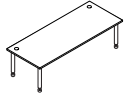

BT 07 BA
160/120/72
BT 07 HV
160/120/68-78

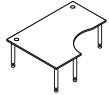

BT 08 BA
180/120/72
BT 08 HV
180/120/68-78

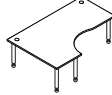

BT 09 BA
160/100/72
BT 09 HV
160/100/68-78

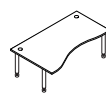

BT 10 BA
160/100/72
BT 10 HV
160/100/68-78

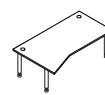

BT 11 BA
200/100/72
BT 11 HV
200/100/68-78

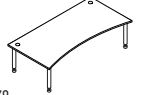

BT 12 BA
160/100/72
BT 12 HV
160/100/68-78



BT 13 BA
180/100/72
BT 13 HV
180/100/68-78

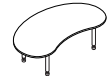

BT 14 BA
180/100/72
BT 14 HV
180/100/68-78



BT 15 BA
210/130/72
BT 15 HV
210/130/68-78



PRZYSTAWKI / BESPRECHUNGSANSÄTZE / DESK EXTENSIONS / AJUTAGES

AP 01 BA
80/40/72
AP 01 HV
80/40/68-78



AP 02 BA
160/80/72
AP 02 HV
160/80/68-78



AP 03 BA
161/120/72
AP 03 HV
161/120/68-78



AP 04 BA
90/100/72
AP 04 HV
90/100/68-78



AP 05
80/80/2,5



AP 06 BA
60/80/72
AP 06 HV
60/80/68-78



AP 07 BA
80/80/72
AP 07 HV
80/80/68-78



AP 08 BA
120/80/72
AP 08 HV
120/80/68-78



AP 09 BA
80/80/72
AP 09 HV
80/80/68-78



AP 10 BA
120/120/72
AP 10 HV
120/120/68-78



AP 11 BA
80/130/72
AP 11 HV
80/130/68-78



STÓŁY KONFERENCYJNE / KONFERENZTISCHE / CONFERENCE TABLES / TABLES DE CONFÉRENCE

KT 12
Ø 80/72



KT 02
160/100/72



KT 03
180/100/72



KT 04
200/100/72



KT 05
220/100/72



KT 10
180/100/72



KT 01
Ø 120/72



KT 06
160/100/72



KT 07
180/100/72



KT 08
200/100/72



KT 09
220/100/72



KT 11
220/100/72



**BLENDY PŁYTOWE
SICHTBLENDEN
MODESTY PANELS
FAUSSE BAIE EN PLAQUE**

PB 01
63,5/40/1,8
PB 02
83,5/40/1,8
PB 03
103,5/40/1,8
PB 04
123,5/40/1,8
PB 05
143,5/40/1,8
PB 07
163,5/40/1,8
PB 06
183,5/40/1,8
PB 08
82,5/40/1,8

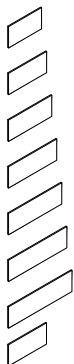

**BLENDY METALOWE
LOCHBLECHSICHTBLENDEN
METAL MODESTY PANELS
FAUSSE BAIE EN MÉTAL**

BB 01
63,5/40/0,8
BB 02
83,5/40/0,8
BB 03
103,5/40/0,8
BB 04
123,5/40/0,8
BB 05
143,5/40/0,8
BB 07
163,5/40/0,8
BB 06
183,5/40/0,8
BB 08
82,5/40/0,8

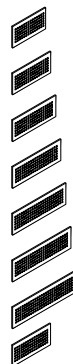

**PRZEGRODY PŁYTOWE
ORGANISATIONSWÄNDE
SCREENS
CLOISONS DE PLAQUE**

SW 01
80/50/0,8
SW 02
100/50/0,8
SW 03
120/50/0,8
SW 04
140/50/0,8
SW 05
160/50/0,8
SW 07
180/50/0,8
SW 06
200/50/0,8

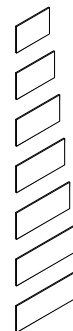

**KANAŁY KABLOWE
KABELKANAL
WIRING SUPPORT
CANAL POUR LES CABLES**

KF 02
57/10/9
KF 03
77/10/9
KF 04
97/10/9
KF 05
117/10/9
KF 06
137/10/9
KF 08
157/10/9
KF 07
177/10/9
KF 01
H.72

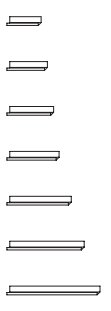

NADSTAWKI / AUFSÄTZE / RAISED-UP ELEMENTS / MEUBLES SUPERPOSES

AA 01
120/41/85



AA 02
160/41/85



AA 03 SW
140/41/85
AA 03 PB
140/41/85



AA 04 SW
160/41/85
AA 04 PB
160/41/85



AA 05
120/30/47



AA 06
160/30/47



AA 07 SW
120/30/47
AA 07 PB
120/30/47



AA 08 SW
160/30/47
AA 08 PB
160/30/47



ELEMENTY METALOWE / METALLELEMENTE / METAL ELEMENTS / ÉLÉMENTS EN MÉTAL

MF 02

CPU - Halter
Zawieszka komputera
CPU holder
Accroche de l'ordinateur
23/55/50



MF 04



MF 05
3/9/4



NOGI / FÜßE / LEGS / PIEDS

MF 06



MF 07



MF 08



MF 09



KONTENERY MOBILNE / MOBILCONTAINER / MOBILE CABINETS / CONTENEURS MOBILES

MC 01
46/60/106



MC 02
46/60/106



MC 03
86/60/110



MC 04
53,2/60/108



KONTENERY METALOWE / METAL CONTAINERS /

KM 4/1
42/53,3/55,5



KM 4/2
42/53,3/55,5



KM 4/3
42/58,3/69,3



KM 4/4
42/79/69,3



KONTENERY / CONTAINER / DRAWERS / CONTENEURS

K 1/1
43/52,5/55



K 1/2
43/52,5/55



K 1/3
43/60/73



K 1/4
43/60/73



K 1/5
43/80/73



K 1/6
43/80/73



K 1/7
43/60-80/73



K 1/8
43/60-80/73



KONTENERY / CONTAINER / DRAWERS / CONTENEURS - SYSTEM CE

K 2/1
43,2/57,5/59,8



K 2/2
43,2/57,5/59,8



K 2/3
43,2/80/59,8



K 2/4
43,2/80/59,8



K 2/5
43,2/80/72,6



K 2/6
43,2/80/72,6



K 2/7
43,2/80/72,6



K 2/8
43,2/80/72,6



KONTENERY / CONTAINER / DRAWERS / CONTENEURS - SYSTEM C+

K 3/1
43,2/57,5/59,8



K 3/2
43,2/57,5/59,8



K 3/3
43,2/80/59,8



K 3/4
43,2/80/59,8



K 3/5
43,2/80/72,6



K 3/6
43,2/80/72,6



K 3/7
43,2/80/72,6



K 3/8
43,2/80/72,6



SZAFY H-72 / SCHRÄNKE H-72 / CUPBOARDS H-72 / ARMOIRES H-72

S 72/1
80/43/72



S 72/2
80/43/72



S 72/3
80/43/72



S 72/4
120/43/72

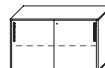

S 72/5
120/53/72



SZAFY 2 OH / SCHRÄNKE 2 OH / CUPBOARDS 2 OH / ARMOIRES 2 OH

S 2/1 40/43/78,4		S 2/2 40/43/78,4		S 2/3 40/43/78,4	
S 2/4 40/43/78,4		S 2/5 80/43/78,4		S 2/6 80/43/78,4	
S 2/7 80/43/78,4		S 2/8 80/43/78,4		S 2/9 80/43/78,4	
S 2/10 80/60/78,4					

SZAFY 3 OH / SCHRÄNKE 3 OH / CUPBOARDS 3 OH / ARMOIRES 3 OH

S 3/1 40/43/116,8		S 3/2 40/43/116,8		S 3/5 40/43/116,8	
S 3/6 40/43/116,8		S 3/3 80/43/116,8		S 3/4 80/43/116,8	
S 3/7 80/43/116,8		S 3/8 80/43/116,8		S 3/9 80/43/116,8	

SZAFY 4 OH / SCHRÄNKE 4 OH / CUPBOARDS 4 OH / ARMOIRES 4 OH

S 4/1 40/43/154,3		S 4/2 40/43/154,3		S 4/3 40/43/154,3	
S 4/4 40/43/154,3		S 4/5 80/43/154,3		S 4/6 80/43/154,3	
S 4/7 80/43/154,3		S 4/8 80/43/154,3		S 4/9 80/43/154,3	
S 4/10 80/43/154,3		S 4/11 80/43/154,3		S 4/12 80/43/154,3	
S 4/13 80/43/154,3		S 4/14 80/43/154,3		S 4/15 80/43/154,3	

SZAFY 5 OH / SCHRÄNKE 5 OH / CUPBOARDS 5 OH / ARMOIRES 5 OH

S 5/1 40/43/192,7		S 5/2 40/43/192,7		S 5/3 40/43/192,7	
S 5/4 40/43/192,7		S 5/5 80/43/192,7		S 5/6 80/43/192,7	
S 5/7 80/43/192,7		S 5/8 80/43/192,7		S 5/9 80/60/192,7	
S 5/10 80/43/192,7		S 5/11 80/43/192,7		S 5/12 80/43/192,7	
S 5/13 80/43/192,7		S 5/14 80/43/192,7		S 5/15 80/43/192,7	
S 5/16 80/43/192,7					

**SZAFY PRZESUWNE / SCHIEBETÜRENSCHRÄNKE /
CUPBOARDS WITH SLIDING DOORS / ARMOIRES AVEC PORTES MOBILES**

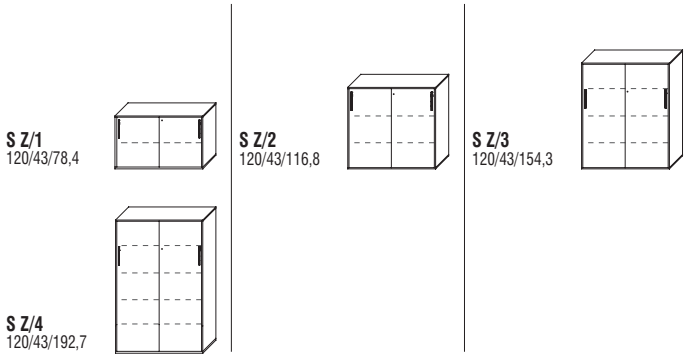

**SZAFY ŻALUZJOWE / JALOUSIENSCHRÄNKE /
SHUTTER DOORS CABINETS / ARMOIRES A RIDEAUX**

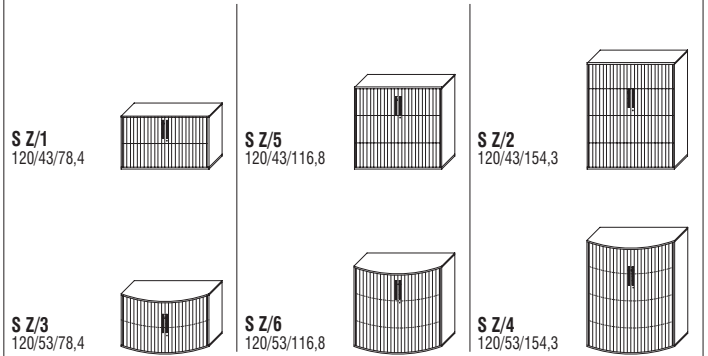

**PÓŁKI PŁYGINOWE / HOLZFACHBODEN /
BOARD SHELVES / TABLETTE EN PLAQUE**

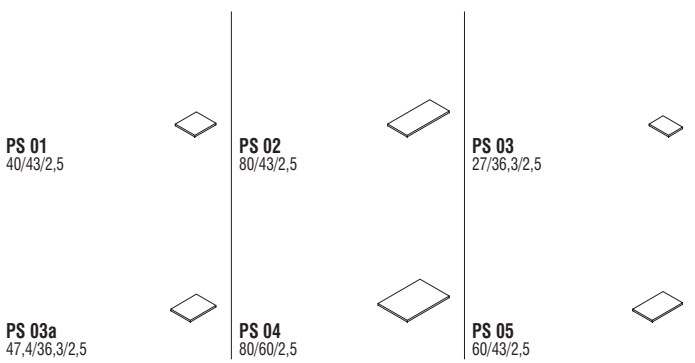

**PÓŁKI METALOWE / METALLFACHBODEN /
METAL SHELVES / TABLETTE EN MÉTAL**

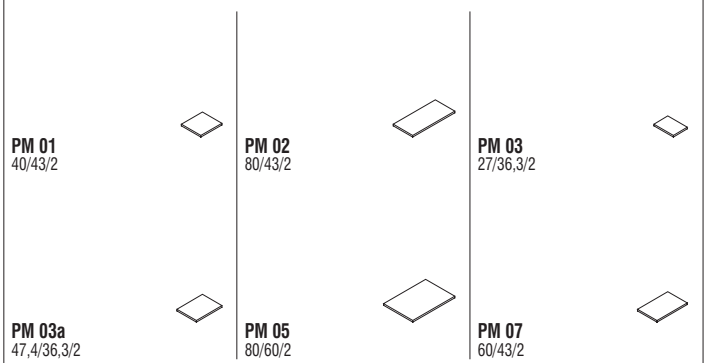

**WIĘCZE POŚREDNIE / ZWISCHENKONSTRUKTIONSBODEN /
INTERMEDIATE SHELVES / HAUT INTERMÉDIAIRES**

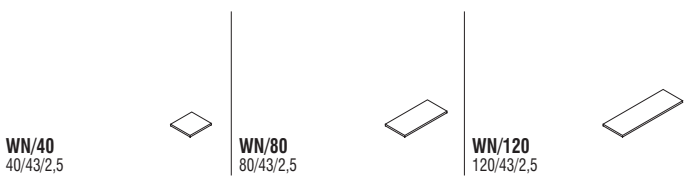

**METALLELEMENTE / ELEMENTY METALOWE /
METAL ELEMENTS / ÉLÉMENTS EN MÉTAL**

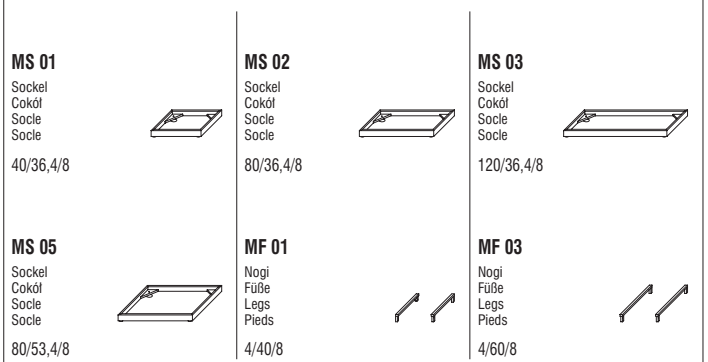

**Beispielhafte Arbeitsplätze.
Przykładowe kompozycje.
Sample arrangements.
Exemples des compositions.**

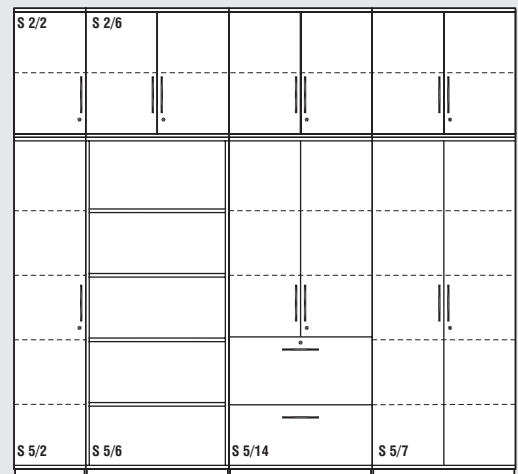
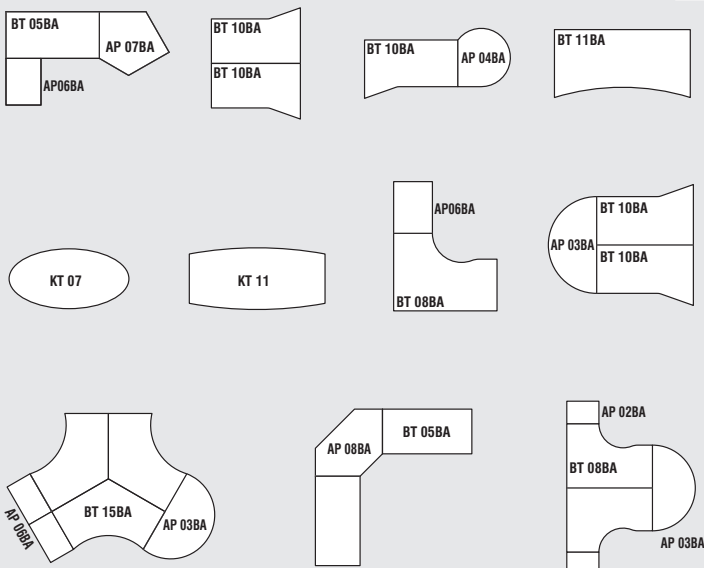



mebelux®

www.mebelux.com.pl

