



brand



nowoczesna architektura mebli.
oszczędna forma i szlachetne materiały.
ekskluzywne uzupełnienie nowoczesnego wnętrza.
modern furniture design.
simple form and outstanding natural materials.
an exquisite addition to contemporary interiors.

b e n e d

design by **Maciej Karpiak**





biel i minimalistyczna forma.
wrażenie niezwyklej lekkości.
**white and minimalist form giving
the impression of incredible lightness.**

for teamwork.





optymalne wykorzystanie przestrzeni.
optimal usage of space.

back up.





dekonstruktywistyczna forma frontu w grze kontrastów.
deconstructive shape of front in the clash of contrasts.

breakthrough.



gniazda zasilania i internetu pod estetyczną osłoną.
power and internet sockets under aesthetic coverings.

hidden power.









prostokątne podziały antracytowej powierzchni.
niezakłócony spokój formy.
rectangularly divided anthracite surfaces.
undisturbed tranquility of form.

push to open.





iluminacja formy. światło odbite w trójkątnych
płaszczyznach trójwymiarowego frontu.
**illumination of shape. light reflected
in three-dimensional triangles on the front.**

diamond shine.





antracyt, czern i biel
- idealne tło do kreatywnego działania.
anthracite, black and white
- the ideal backdrop for creative activity.

quiet background.

szybkie dostosowanie osobistej przestrzeni do charakteru pracy.
quick adjustment of personal space to specific line of work.

flexibility.







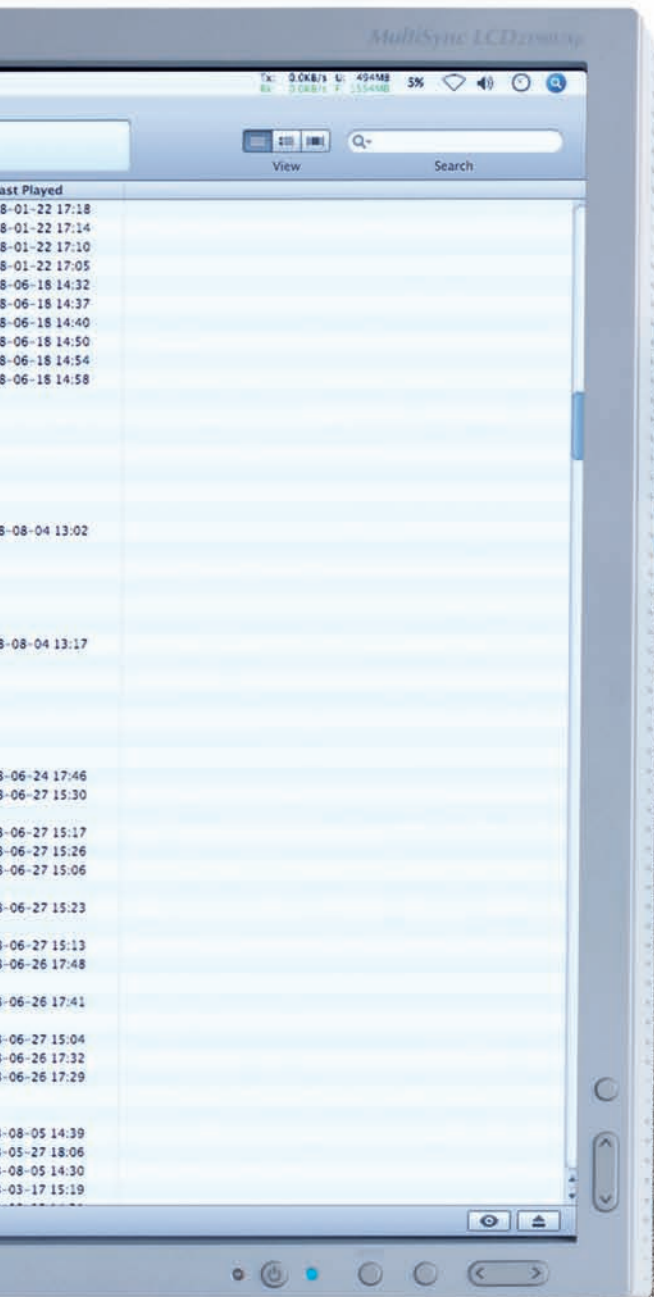

Victone Winner
207/629 3628





akustyczna przegroda o wielu funkcjach.
większa przestrzeń pracy.
multi-purpose acoustic screen.
greater workspace.

at hand's reach.









komunikacja i prywatność
w grupie indywidualistów.
communication and privacy
in a group of individualists.

communication & privacy.





subtelne listwowe uchwyty.
połysk i rytm szklanych frontów.
subtle panel handles.
glossed and rhythm glass fronts.

rhythm & gloss.



Bella Toscana
Donna Form Arcquo otto
2017/2017 in bianco



harmonia szlachetnych materiałów z minimalistyczną formą.
harmony of outstanding natural materials and minimalist form.

noble place.



labirynt kolorów za przejrzystą osłoną.
a labyrinth of colours behind a transparent cover.

slideshow.



KOLORY BLATÓW BIUREK I BLENDY / **WORKTOPS AND BLENDS**

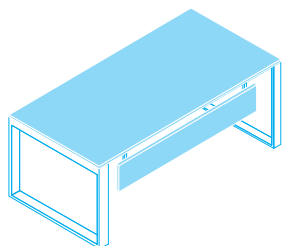

OKLEINA NATURALNA /
NATURAL VENEER



HEBAN MAKASAR



DĄB BIELONY / **WHITENED OAK**

MELAMINA /
MELAMINE

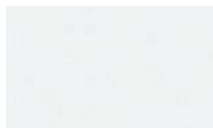

BIAŁY / **WHITE**



ANTRACYT / **ANTHRACITE**

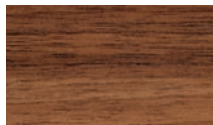

ORZECH / **NUT**

KOLORY STELAŻY / **FRAMES**

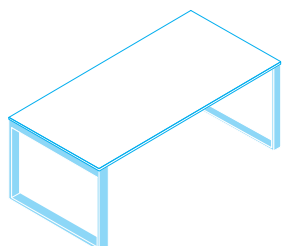

MALOWANE FARBAMI PROSZKOWYMI /
PAINTED WITH POWDER PAINT

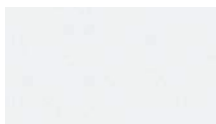

BIAŁY / **WHITE**



ANTRACYT / **ANTHRACITE**

KOLORY PRZEGRÓD NABIURKOWYCH / **SCREENS**

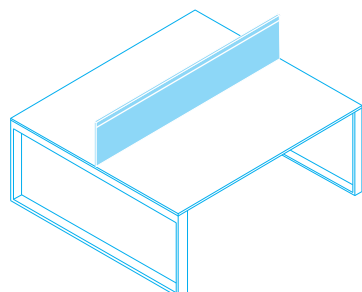

MELAMINA /
MELAMINE

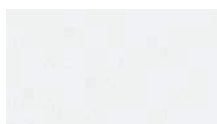

BIAŁY / **WHITE**



ANTRACYT / **ANTHRACITE**



ORZECH / **NUT**

TKANINA W RAMCE ALU /
FABRIC IN ALU FRAME

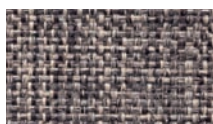

URBAN 14

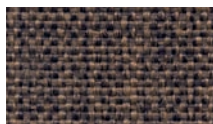

URBAN 15

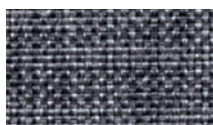

URBAN 52



BASIC 23

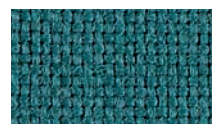

ONYX X-01



ONYX X-02



ONYX X-04



ONYX X-11

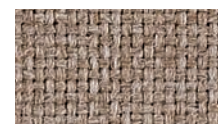

ONYX X-13

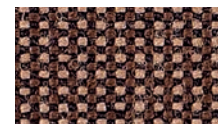

ONYX X-16

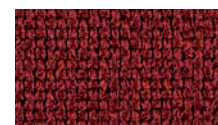

ONYX X-19



ONYX X-22

KOLORY KORPUSÓW ZEWNĘTRZNYCH / EXTERNAL CARCASSES

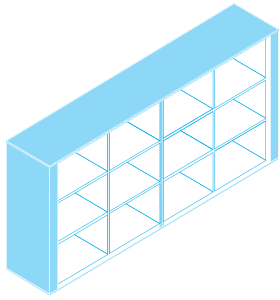

OKLEINA NATURALNA /
NATURAL VENEER

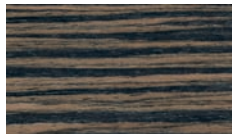

HEBAN MAKASAR



DĄB BIELONY / WHITENED OAK

MELAMINA /
MELAMINE

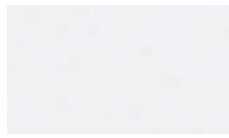

BIAŁY / WHITE



ANTRACYT / ANTHRACITE



ORZECH / NUT

KOLORY KORPUSÓW WEWNĘTRZNYCH / INTERNAL CARCASSES

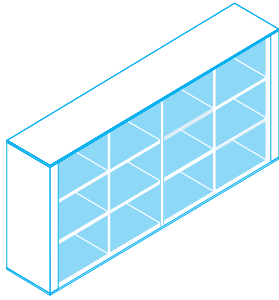

MELAMINA /
MELAMINE

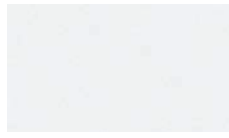

BIAŁY / WHITE



ANTRACYT / ANTHRACITE

KOLORY FRONTÓW ZEWNĘTRZNYCH / EXTERNAL FRONTS

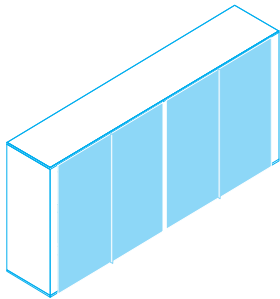

OKLEINA NATURALNA /
NATURAL VENEER

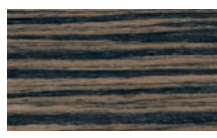

HEBAN MAKASAR



DĄB BIELONY /
WHITENED OAK

MELAMINA /
MELAMINE

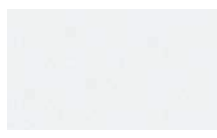

BIAŁY / WHITE

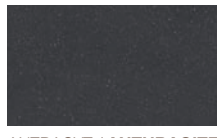

ANTRACYT / ANTHRACITE



ORZECH / NUT

SZKŁO LACOBEL W RAMCE ALU /
GLASS LACOBEL IN ALU FRAME



BIAŁY / WHITE



ŻÓŁTY / YELLOW



NIEBIESKI / BLUE



ANTRACYT / ANTHRACITE



ZIELONY / GREEN



CZARNY / BLACK

SZKŁO TRANSPARENTNE
BRAZOWE W RAMCE ALU /
TRANSPARENT BROWN
GLASS IN ALU FRAME



INNE KOLORY LACOBEL NA SPECJALNE ZAMÓWIENIE /
MORE COLOURS AVAILABLE FOR INDIVIDUAL ORDERS

KOLORY FRONTÓW WEWNĘTRZNYCH / INTERNAL FRONTS

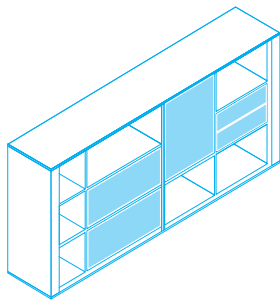

MELAMINA /
MELAMINE

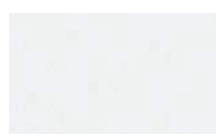

BIAŁY / WHITE



ANTRACYT / ANTHRACITE

LAKIEROWANY MDF /
LACQUERED MDF



BIAŁY / WHITE



ŻÓŁTY / YELLOW



NIEBIESKI / BLUE



ANTRACYT / ANTHRACITE



ZIELONY / GREEN



CZARNY / BLACK

MOŻLIWOŚĆ WYKONANIA WSZYSTKICH BRYŁ W NATURALNEJ OKLEINIE / ALL THE ELEMENTS AVAILABLE IN NATURAL VENEER ON SPECIAL REQUEST

BIURKA GABINETOWE
EXECUTIVE DESKS

BR 100
H 732, W 1804, D 904
BR 110
H 732, W 2004, D 904

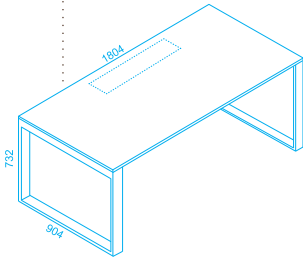

BR 241
PIÓRNIK DO BIURKA
PENCIL-CASE FOR THE DESK
(BR 100, BR 101, BR 110, BR 111)
DŁUGOŚĆ / LENGTH 750 mm
BR 250
MEDIAPORT / MEDIAPORT



BR 101
H 732, W 1804, D 904
BR 111
H 732, W 2004, D 904

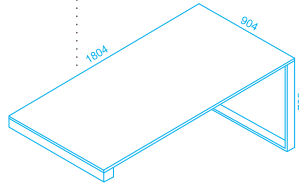

BIURKO GABINETOWE OPIERANE JEDNOSTRONNIE
O KOMODĘ, KONTENEREK LUB SZAFKĘ PC
EXECUTIVE DESK BASED FROM ONE SIDE
ON CABINET, PEDESTAL OR A COMPUTER CABINET

BR 210
BLENDY PODBIURKOWA DO BIURKA 1400
UNDERDESK BLEND FOR THE DESK 1400
BR 211
BLENDY PODBIURKOWA DO BIURKA 1600
UNDERDESK BLEND FOR THE DESK 1600
BR 212
BLENDY PODBIURKOWA DO BIURKA 1800
UNDERDESK BLEND FOR THE DESK 1800
BR 213
BLENDY PODBIURKOWA DO BIURKA 2000
UNDERDESK BLEND FOR THE DESK 2000

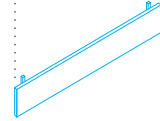

BIURKA PRACOWNICZE
OFFICE DESKS

BR 140
H 732, W 1804, D 804
BR 130
H 732, W 1604, D 804
BR 120
H 732, W 1404, D 804

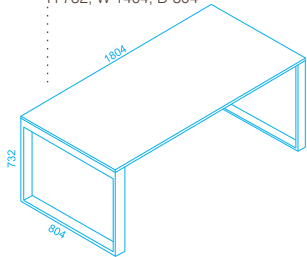

BR 141
H 732, W 1804, D 804
BR 131
H 732, W 1604, D 804
BR 121
H 732, W 1404, D 804

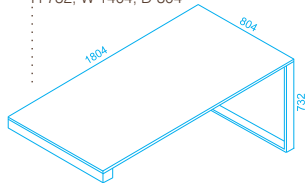

BIURKO PRACOWNICZE OPIERANE JEDNOSTRONNIE
O KOMODĘ LUB SZAFKĘ PC
WORK DESK, BASED FROM ONE SIDE
ON CABINET OR COMPUTER CABINET

BR 152
H 92, W 1804, D 804
BR 151
H 92, W 1604, D 804
BR 150
H 92, W 1404, D 804

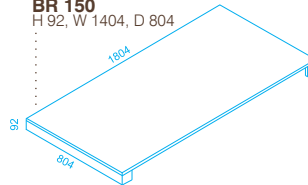

BIURKO PRACOWNICZE POMOSTOWE OPIERANE
DWUSTRONNIE O KOMODĘ LUB SZAFKĘ PC
BRIDGE WORK DESK, BASED FROM TWO SIDES
ON CABINET OR COMPUTER CABINET

BR 162
H 732, W 1804, D 1604
BR 160
H 732, W 1604, D 1604

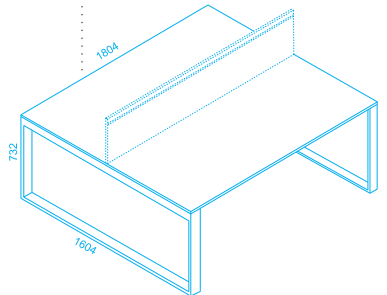

BR 233
PRZEGRODA TAPICEROWANA DŁUGOŚĆ 1804
UPHOLSTERED SCREEN LENGTH 1804
BR 231
PRZEGRODA TAPICEROWANA DŁUGOŚĆ 1604
UPHOLSTERED SCREEN LENGTH 1604

BR 232
PRZEGRODA Z PŁYTY LAMINOWANEJ DŁUGOŚĆ 1804
LAMINATED BOARD SCREEN LENGTH 1804
BR 230
PRZEGRODA Z PŁYTY LAMINOWANEJ DŁUGOŚĆ 1604
LAMINATED BOARD SCREEN LENGTH 1604

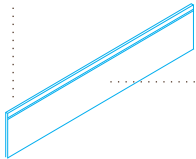

BR 163
H 732, W 1804, D 1604
BR 161
H 732, W 1604, D 1604

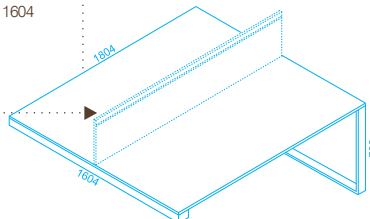

BIURKO PRACOWNICZE BENCH OPIERANE
JEDNOSTRONNIE O KOMODĘ LUB SZAFKĘ PC
BENCH WORK DESK, BASED FROM ONE SIDE
ON CABINET OR COMPUTER CABINET

BR 171
H 92, W 1804, D 1604
BR 170
H 92, W 1604, D 1604

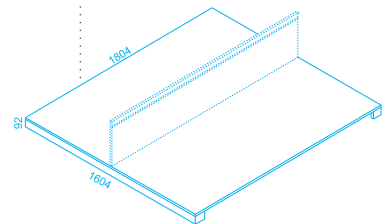

BIURKO PRACOWNICZE BENCH OPIERANE
DWUSTRONNIE O KOMODĘ LUB SZAFKĘ PC
BENCH WORK DESK, BASED FROM TWO SIDES
ON CABINET OR COMPUTER CABINET

SZAFKI NA PC
COMPUTER CABINETS

BR 01

BR 02

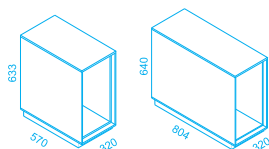

KONTENERKI PODBIURKOWE
UNDERDESK PEDESTALS

BR 03

BR 04

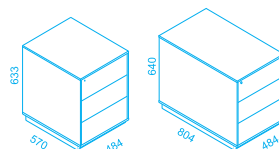

BR 05

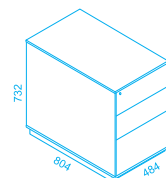

KONTENEREK
DO WYSOKOŚCI BLATU
PEDESTALS (HEIGHT
UP TO WORKTOP)

KOMODY PODBIUROKOWE UNDERDESK CABINETS

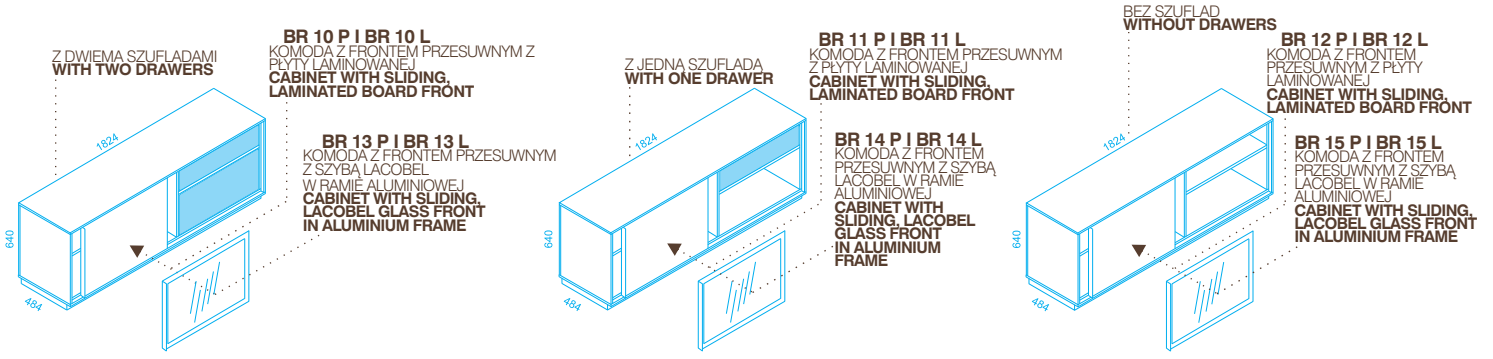

KOMODY PODBIUROKOWE (dla dwóch biurków) UNDERDESK CABINETS (for two desks)

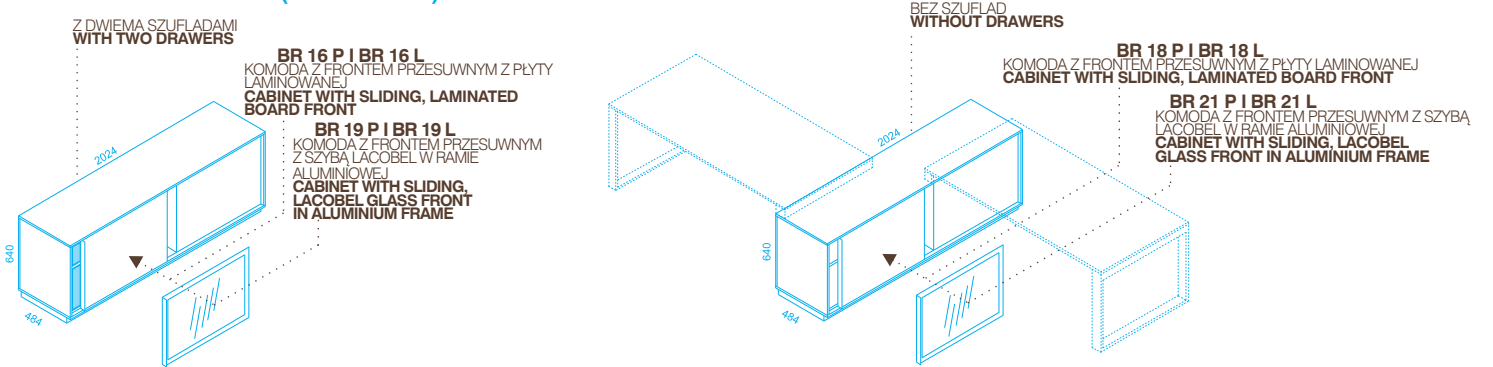

KOMODY PODBIUROKOWE GABINETOWE UNDERDESK OFFICE CABINETS

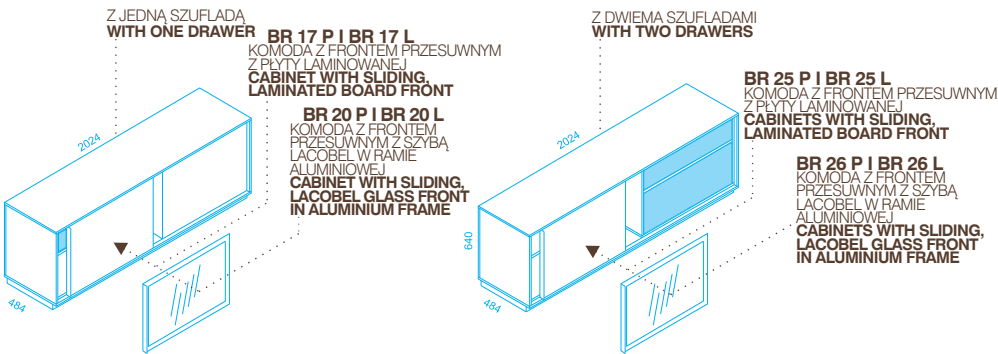

AKCESORIA DO BIUREK DESK ACCESSORIES

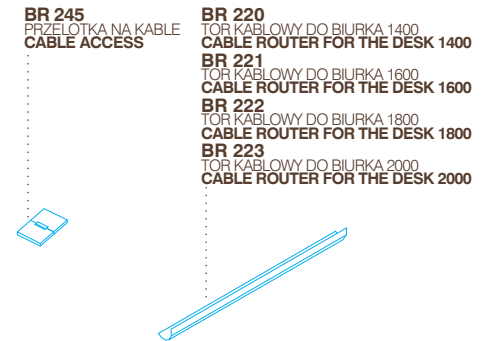

STOŁY I STOLIKI TABLES AND COFFEE TABLE

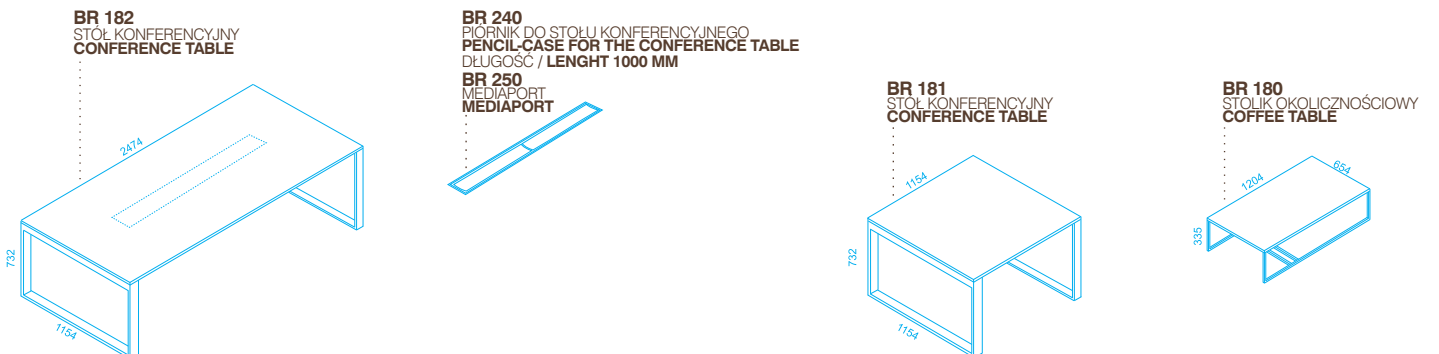

SZAFKI WISZĄCE 1 OH
WALL CABINETS 1 OH

BR 80
SZAFKA BEZ FRONTÓW
CABINET WITHOUT FRONTS

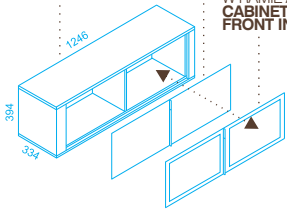

BR 81
SZAFKA Z FRONTEM Z PŁYTY LAMINOWANEJ
CABINET WITH LAMINATED BOARD FRONT

BR 82
SZAFKA Z FRONTEM Z SZYBĄ LACOBEL
W RAMIE ALUMINIOWEJ
CABINET WITH LACOBEL GLASS
FRONT IN ALUMINIUM FRAME

BR 83
SZAFKA BEZ FRONTÓW
CABINET WITHOUT FRONTS

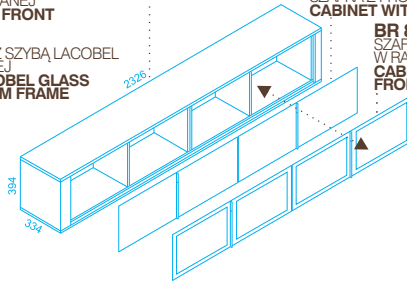

BR 84
SZAFKA Z FRONTEM Z PŁYTY LAMINOWANEJ
CABINET WITH LAMINATED BOARD FRONT

BR 85
SZAFKA Z FRONTEM Z SZYBĄ LACOBEL
W RAMIE ALUMINIOWEJ
CABINET WITH LACOBEL GLASS
FRONT IN ALUMINIUM FRAME

BR 86
SZAFKA Z FRONTEM Z PŁYTY LAMINOWANEJ
CABINET WITH LAMINATED BOARD FRONT

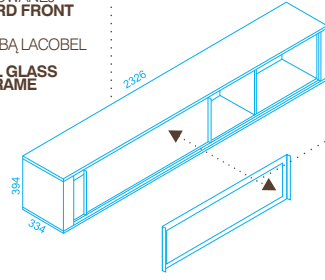

BR 87
SZAFKA Z FRONTEM Z SZYBĄ
LACOBEL W RAMIE ALUMINIOWEJ
CABINET WITH LACOBEL GLASS
FRONT IN ALUMINIUM FRAME

KOMODY WOLNOSTOJĄCE WYSOKOŚĆ 1 OH
SINGLE CABINETS HEIGHT 1 OH

BR 90
SZAFKA BEZ FRONTÓW
CABINET WITHOUT FRONTS

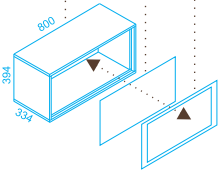

BR 91
SZAFKA Z FRONTEM Z PŁYTY LAMINOWANEJ
CABINET WITH LAMINATED BOARD FRONT

BR 92
SZAFKA Z FRONTEM Z SZYBĄ
LACOBEL W RAMIE ALUMINIOWEJ
CABINET WITH LACOBEL GLASS
FRONT IN ALUMINIUM FRAME

BR 93
SZAFKA BEZ FRONTÓW
CABINET WITHOUT FRONTS

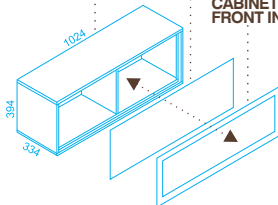

BR 94
SZAFKA Z FRONTEM Z PŁYTY LAMINOWANEJ
CABINET WITH LAMINATED BOARD FRONT

BR 95
SZAFKA Z FRONTEM Z SZYBĄ
LACOBEL W RAMIE ALUMINIOWEJ
CABINET WITH LACOBEL GLASS
FRONT IN ALUMINIUM FRAME

BR 30
KOMODA BEZ FRONTÓW
CABINET WITHOUT FRONTS

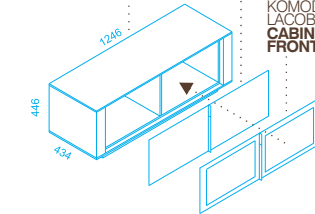

BR 31
KOMODA Z FRONTEM Z PŁYTY LAMINOWANEJ
CABINET WITH LAMINATED BOARD FRONT

BR 32
KOMODA Z FRONTEM Z SZYBĄ
LACOBEL W RAMIE ALUMINIOWEJ
CABINET WITH LACOBEL GLASS
FRONT IN ALUMINIUM FRAME

BR 33
KOMODA BEZ FRONTÓW
CABINET WITHOUT FRONTS

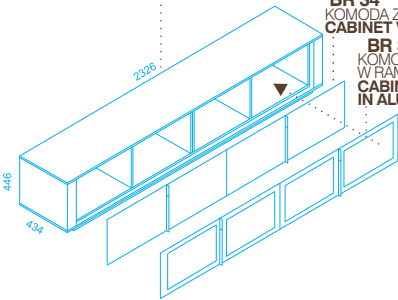

BR 34
KOMODA Z FRONTEM Z PŁYTY LAMINOWANEJ
CABINET WITH LAMINATED BOARD FRONT

BR 35
KOMODA Z FRONTEM Z SZYBĄ LACOBEL
W RAMIE ALUMINIOWEJ
CABINET WITH LACOBEL GLASS
FRONT IN ALUMINIUM FRAME

BR 36
KOMODA Z FRONTEM PRZESUWNYM Z PŁYTY LAMINOWANEJ
CABINET WITH SLIDING, LAMINATED BOARD FRONT

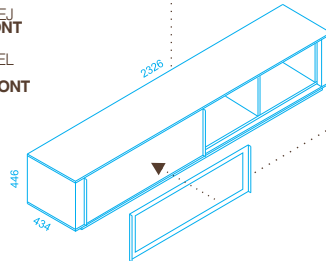

BR 37
KOMODA Z FRONTEM PRZESUWNYM Z SZYBĄ LACOBEL
W RAMIE ALUMINIOWEJ
CABINET WITH SLIDING, LACOBEL GLASS
FRONT IN ALUMINIUM FRAME

BR 200
SZUFLADA AKTOWA DO KOMÓD WOLNOSTOJĄCYCH
BEZ FRONTÓW I Z FRONTEM PRZESUWNYM
FILE DRAWER FOR SINGLE CHEST OF DRAWERS
WITHOUT FRONTS AND WITH SLIDING FRONTS

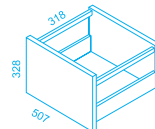

KOMODY WOLNOSTOJĄCE WYSOKOŚĆ 2 OH
SINGLE CABINETS HEIGHT 2 OH

BR 40
KOMODA BEZ FRONTÓW
CABINET WITHOUT FRONTS

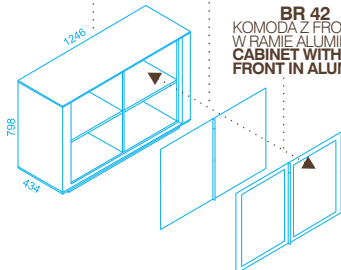

BR 41
KOMODA Z FRONTEM Z PŁYTY LAMINOWANEJ
CABINET WITH LAMINATED BOARD FRONT

BR 42
KOMODA Z FRONTEM Z SZYBĄ LACOBEL
W RAMIE ALUMINIOWEJ
CABINET WITH LACOBEL GLASS
FRONT IN ALUMINIUM FRAME

BR 43
KOMODA BEZ FRONTÓW
CABINET WITHOUT FRONTS

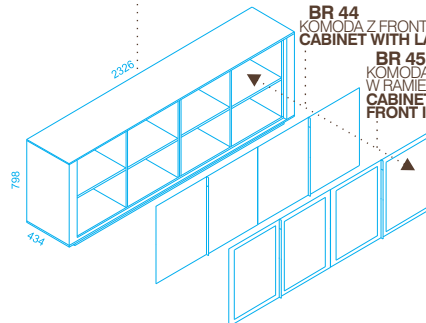

BR 44
KOMODA Z FRONTEM Z PŁYTY LAMINOWANEJ
CABINET WITH LAMINATED BOARD FRONT

BR 45
KOMODA Z FRONTEM Z SZYBĄ LACOBEL
W RAMIE ALUMINIOWEJ
CABINET WITH LACOBEL GLASS
FRONT IN ALUMINIUM FRAME

BR 46
KOMODA Z FRONTEM PRZESUWNYM Z PŁYTY LAMINOWANEJ
CABINET WITH SLIDING, LAMINATED BOARD FRONT

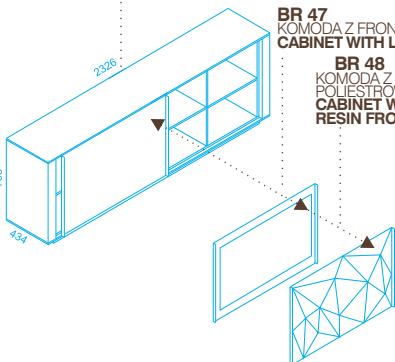

BR 47
KOMODA Z FRONTEM Z SZYBĄ LACOBEL W RAMIE ALUMINIOWEJ
CABINET WITH LACOBEL GLASS FRONT IN ALUMINIUM FRAME

BR 48
KOMODA Z FRONTEM PRZESTRZENNYM Z ŻYWICY
POLIESTROWOJĄcej W RAMIE ALUMINIOWEJ
CABINET WITH THREE-DIMENSIONAL, POLYESTER-GLASS
RESIN FRONT IN ALUMINIUM FRAME

BR 49
KOMODA NA FAJLE
FILE CABINET

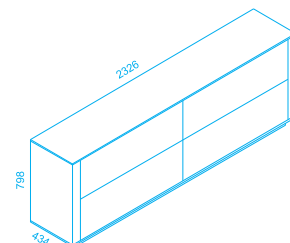

KOMODY WOLNOSTOJACE WYSOKOŚĆ 3 OH
SINGLE CABINETS HEIGHT 3 OH

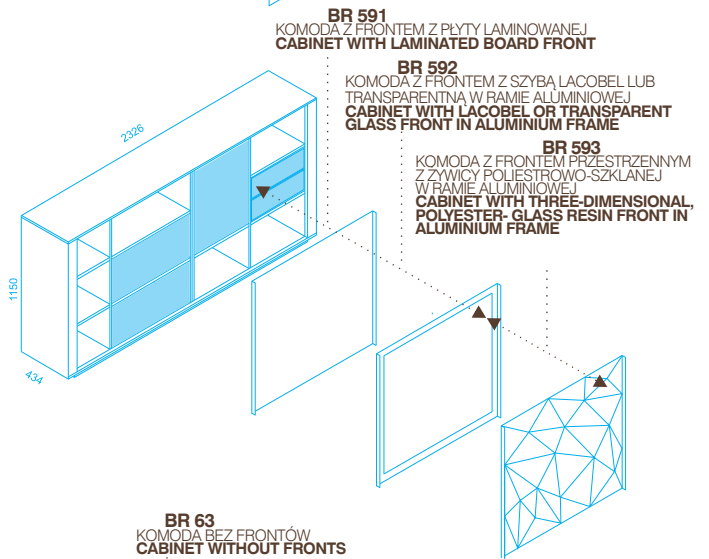
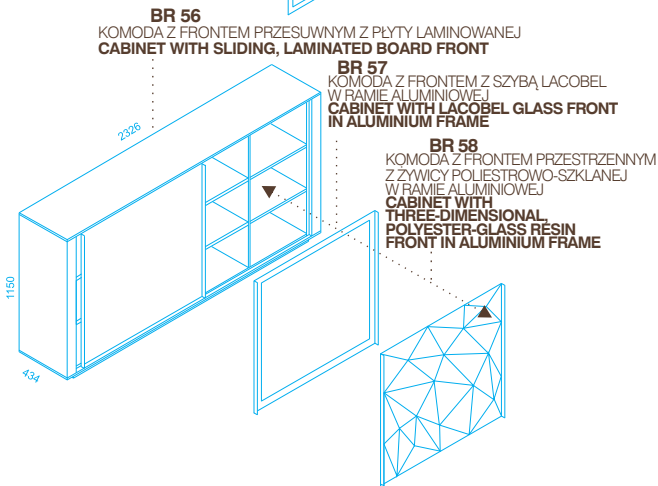
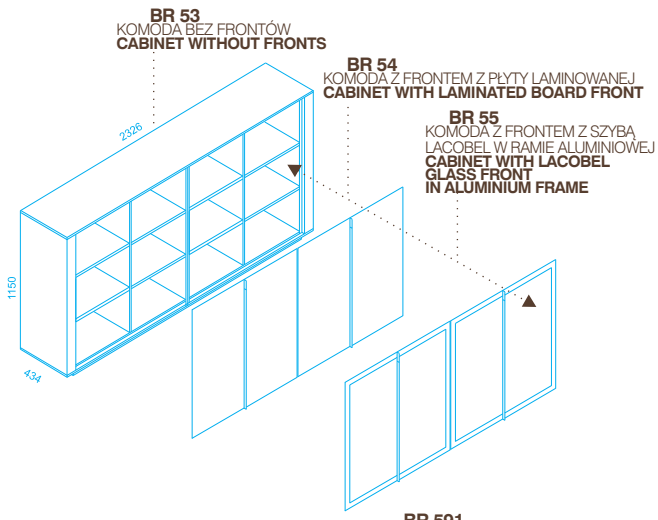
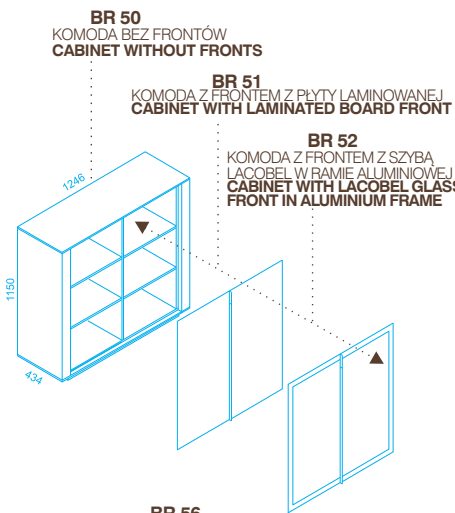

KOMODY WOLNOSTOJACE WYSOKOŚĆ 4 OH
SINGLE CABINETS HEIGHT 4 OH

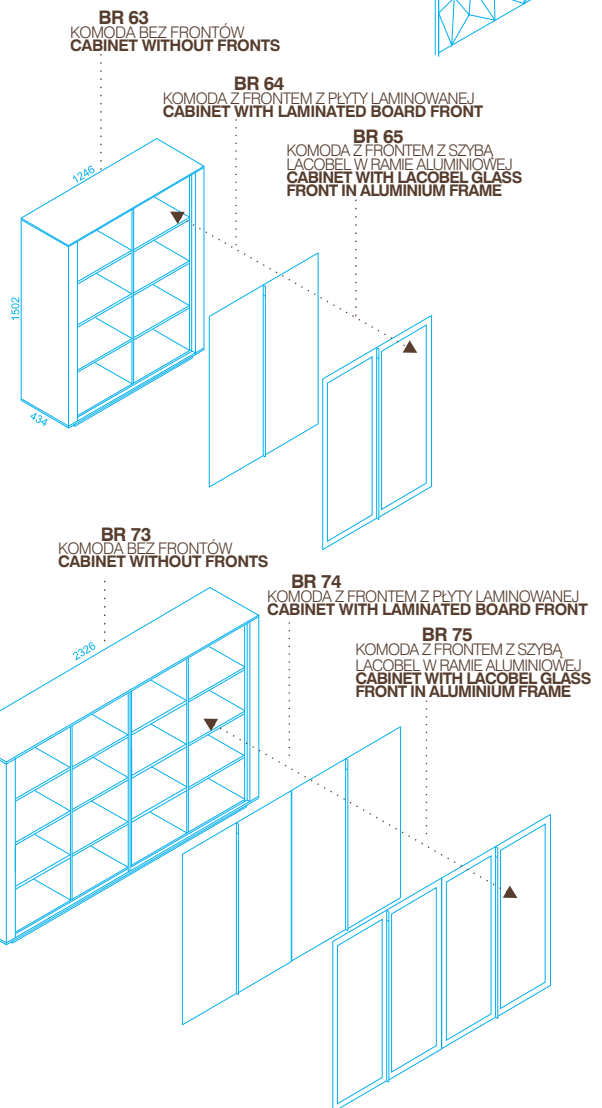
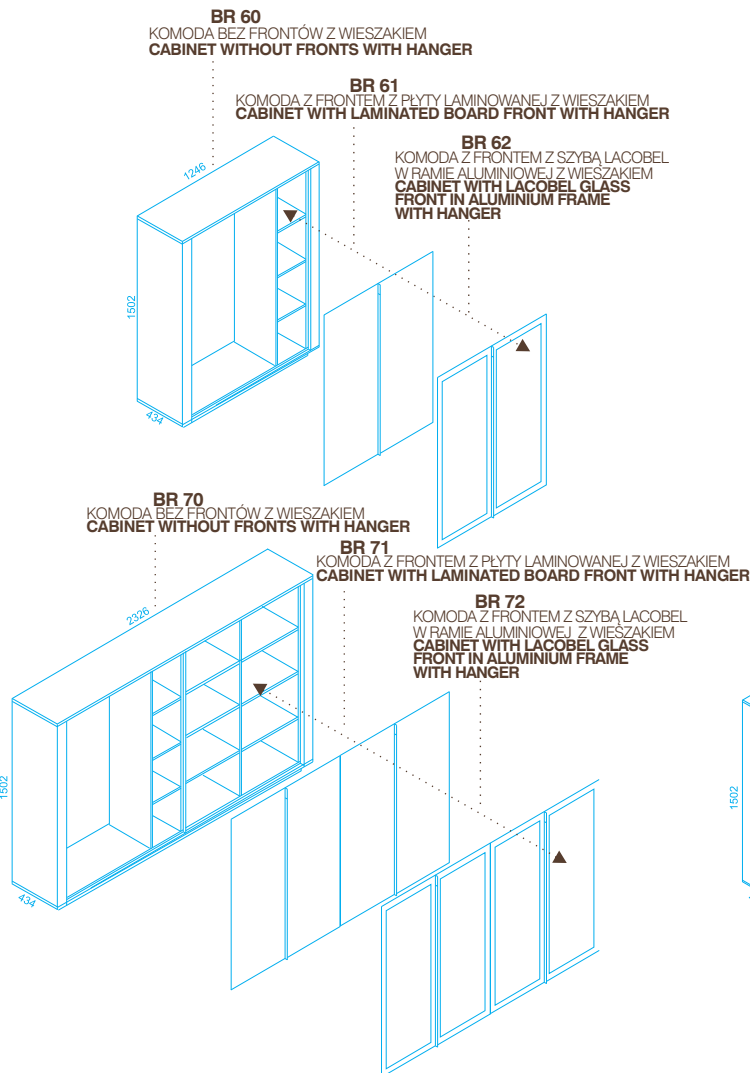

Zdjęcia i projekt / **Photography and design** : FOTOGRAFIA REKLAMOWA RAFAŁ KOLASIŃSKI +48 61 8747033
Dziękujemy za pomoc w sesji zdjęciowej, firmom / **Thanks to** : BEJOT, SITAG, STUDIO ARTEX, Ziii design by Maciej Karpiak

mebelux.

Fabryka Mebli Mebelux Sp. z o.o. ul. Plebiscytowa 3, 14-100 Ostróda tel.+4889 6461222, 6461211 fax +4889 6428353
mebelux@mebelux.com.pl

www.mebelux.com.pl



mebelux.